

Multiports

# M4-SR4

Media Type  
**Hydraulic Oil, Air - Vacuum**

Max. Speed  
**250 RPM**

Max. Pressure  
**250 BAR**

Max. Temperature  
**80 °C**

Connection Type  
**NPT, BSPP, BSPT**

Rotor Size  
**2 x 1/4" - 12 x 3/4"**

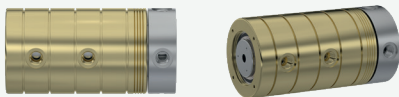
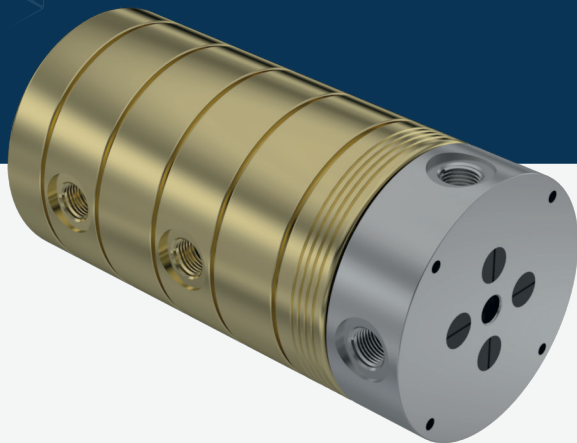

- ✓ Multi flow design
- ✓ Self supported design
- ✓ Dynamic carbon teflon sealing
- ✓ Special design sealing part for different fluids
- ✓ BSP,NPT metric threads inlet's & outlet's
- ✓ Chrom plated sealing surface
- ✓ Brass body
- ✓ Custom connections types are available

Multi-passage rotary unions.

**!** Do not operate without fluid.

## DIMENSIONS

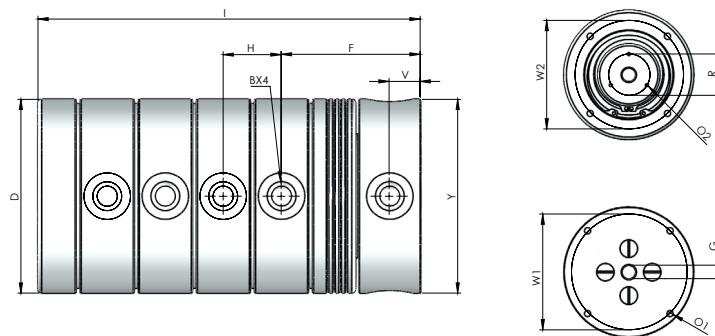

SIZE	MODEL NO	B	YØ	B2	DØ	F	H	I	V	GØ	W1Ø	W2Ø	RØ	O1	O2	KG
4 X 1/4"	M4-44081-200	1/4" NPT	75	1/4" NPT	75	56,20	23,40	134,45	10	7	70	61	18	M6X20	M3X10	4,75
4 X 1/4"	M4-44082-200	1/4" BSP	75	1/4" BSP	75	56,20	23,40	134,45	10	7	70	61	18	M6X20	M3X10	4,75
4 X 1/4"	M4-44083-200	1/4" BSPP	75	1/4" BSPP	75	56,20	23,40	134,45	10	7	70	61	18	M6X20	M3X10	4,75
4 X 3/8"	M4-44101-200	3/8" NPT	90	3/8" NPT	90	72,70	30	203	15	10	70	80	25	M6X20	M3X10	8,95
4 X 3/8"	M4-44102-200	3/8" BSP	90	3/8" BSP	90	72,70	30	203	15	10	70	80	25	M6X20	M3X10	8,95
4 X 3/8"	M4-44103-200	3/8" BSPP	90	3/8" BSPP	90	72,70	30	203	15	10	70	80	25	M6X20	M3X10	8,95
4 X 1/2"	M4-44151-200	1/2" NPT	125	1/2" NPT	125	89,65	37,40	246,50	20	13	112	105	40	M6X20	M3X10	21,65
4 X 1/2"	M4-44152-200	1/2" BSP	125	1/2" BSP	125	89,65	37,40	246,50	20	13	112	105	40	M6X20	M3X10	21,65
4 X 1/2"	M4-44153-200	1/2" BSPP	125	1/2" BSPP	125	89,65	37,40	246,50	20	13	112	105	40	M6X20	M3X10	21,65
4 X 3/4"	M4-44201-200	3/4" NPT	135	3/4" NPT	135	95,35	43,40	273,20	20	18	115	115	45	M8X20	M4X10	27,00
4 X 3/4"	M4-44202-200	3/4" BSP	135	3/4" BSP	135	95,35	43,40	273,20	20	18	115	115	45	M8X20	M4X10	27,00
4 X 3/4"	M4-44203-200	3/4" BSPP	135	3/4" BSPP	135	95,35	43,40	273,20	20	18	115	115	45	M8X20	M4X10	27,00