

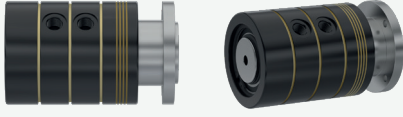

Multiport M2-C2

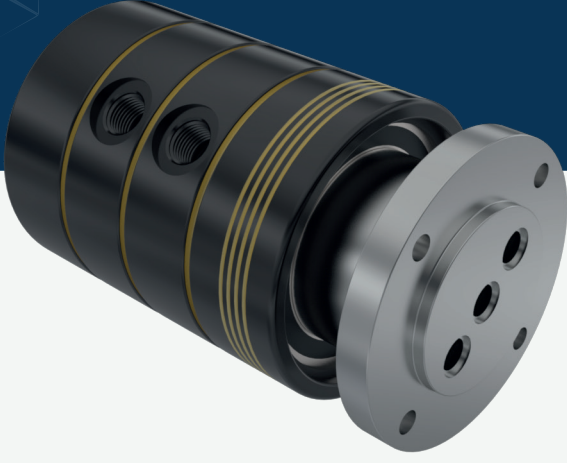

Çoklu döner sızdırmazlık elemanı.

 Akışkan Tipi
Hidrolik Yağ, Hava - Vakum







 Maks. Hız
250 RPM

 Maks. Baskınç
250 BAR

 Maks. Sıcaklık
80 °C

 Bağlantı Tipi
NPT, BSPP, BSPT

 Rotor Ölçüsü
2 x 1/4" - 12 x 3/4"

-  Flanşlı, önden çıkışlı
-  Çelik şaft
-  Özel tasarım akışkana göre sızdırmazlık elemanları
-  Krom kaplı iç sızdırmazlık yüzeyleri
-  Kaplamalı çelik gövde
-  Korozyona, toza, kire dayanıklı kaplama
-  Düşük kaliteli akışkanlarda bile sorunsuz çalışma

 Akışkan olmadan çalıştırmayın.

ÖLÇÜLER

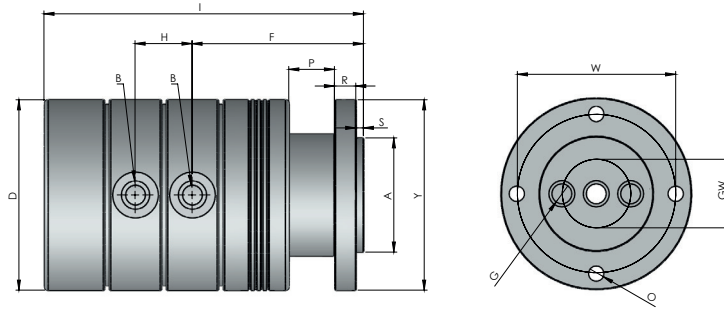

BOYUT	MODEL NO	B	Y Ø	A Ø	G Ø	D Ø	F	H	I	S	P	R	W	GW	O	KG
2 x 1/4"	M2-12081-200	1/4" NPT	81	45	7	80	71	23,40	135,50	3	20	7	70	20	6,50	3,80
2 x 1/4"	M2-12082-200	1/4" BSP	81	45	7	80	71	23,40	135,50	3	20	7	70	20	6,50	3,80
2 x 1/4"	M2-12083-200	1/4" BSPP	81	45	7	80	71	23,40	135,50	3	20	7	70	20	6,50	3,80
2 X 3/8"	M2-12101-200	3/8"NPT	80	45	10	80	85	30	154,30	3	20	7	68	18	6,50	4,40
2 X 3/8"	M2-12102-200	3/8"BSP	80	45	10	80	85	30	154,30	3	20	7	68	18	6,50	4,40
2 X 3/8"	M2-12103-200	3/8"BSPP	80	45	10	80	85	30	154,30	3	20	7	68	18	6,50	4,40
2 X 1/2"	M2-12151-200	1/2"NPT	125	75	13	125	112,50	37,40	210	5	30	14	104	45	10	14,70
2 X 1/2"	M2-12152-200	1/2"BSP	125	75	13	125	112,50	37,40	210	5	30	14	104	45	10	14,70
2 X 1/2"	M2-12153-200	1/2"BSPP	125	75	13	125	112,50	37,40	210	5	30	14	104	45	10	14,70
2 X 3/4"	M2-12201-200	3/4"NPT	135	85	18	135	117,50	43,40	223,80	5	35	12	110	46	11	18,10
2 X 3/4"	M2-12202-200	3/4"BSP	135	85	18	135	117,50	43,40	223,80	5	35	12	110	46	11	18,10
2 X 3/4"	M2-12203-200	3/4"BSPP	135	85	18	135	117,50	43,40	223,80	5	35	12	110	46	11	18,10
2 X 1"	M2-12251-200	1"NPT	164	100	22	164	152,50	50,40	275,50	7	55	16	138	55	13,50	33

2 X 1"	M2-12252-200	1"BSP	164	100	22	164	152,50	50,40	275,50	7	55	16	138	55	13,50	33
2 X 1"	M2-12253-200	1"BSPP	164	100	22	164	152,50	50,40	275,50	7	55	16	138	55	13,50	33
2 X 1 1/4"	M2-12321-200	1 1/4"NPT	230	150	28	230	167,10	65	317	7	55	20	180	85	13,50	78
2 X 1 1/4"	M2-12322-200	1 1/4"BSP	230	150	28	230	167,10	65	317	7	55	20	180	85	13,50	78
2 X 1 1/4"	M2-12323-200	1 1/4"BSPP	230	150	28	230	167,10	65	317	7	55	20	180	85	13,50	78
2 X 1 1/2"	M2-12401-200	1 1/2"NPT	258	190	38	80	198,40	78,40	390	10	55	20	220	105	15,50	123,25
2 X 1 1/2"	M2-12402-200	1 1/2"BSP	258	190	38	80	198,40	78,40	390	10	55	20	220	105	15,50	123,25
2 X 1 1/2"	M2-12403-200	1 1/2"BSPP	258	190	38	80	198,40	78,40	390	10	55	20	220	105	15,50	123,25